

Under the patronage of **HRH Prince Khalid Al-Faisal**
Advisor to the Custodian of the Two Holy Mosques & Governor of Makkah Region



المؤتمر الدولي الثاني والعشرون لإدارة الأصول والمرافق والصيانة
The 22nd International Asset, Facility & Maintenance
Management Conference

Digitization - Excellence - Sustainability

S-01: DIGITALIZATION MODEL AND ASSET HEALTH MANAGEMENT

By Prof. Adolfo Crespo Márquez

26-28 January 2025

The Ritz-Carlton Jeddah, Kingdom of Saudi Arabia

www.omaintec.com #OmaintecConf

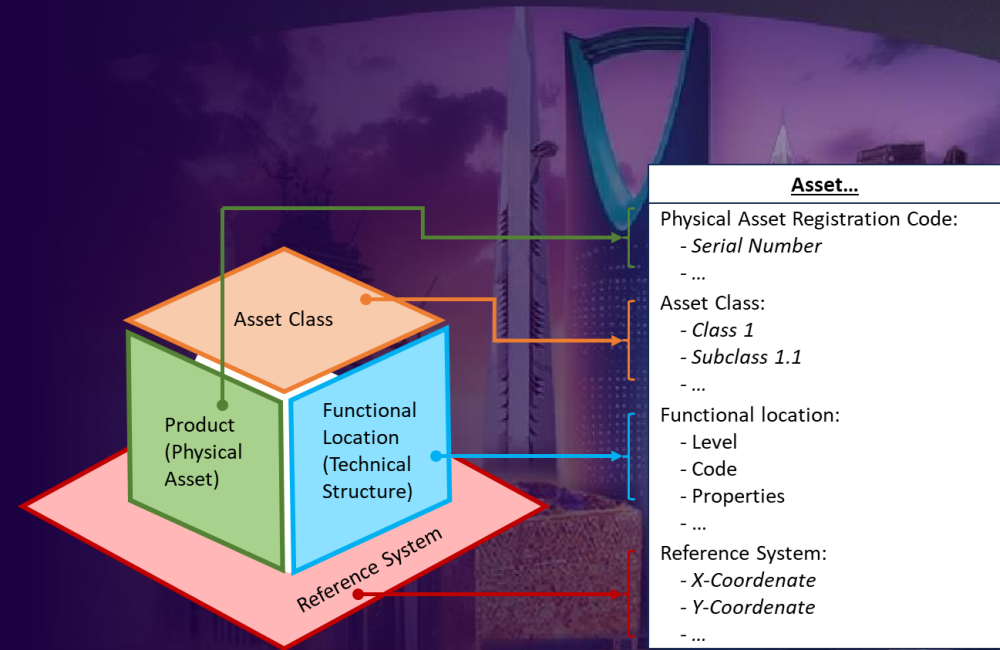

An Initiative By

Organized by



المجلس العربي لإدارة الأصول والمرافق والصيانة
Arab Asset, Facility and Maintenance Management Council



شركة مجموعة المختص • The Specialist Group

S-01: DIGITALIZATION MODEL AND ASSET HEALTH MANAGEMENT



**1 Introduction &
Background**



**2 Data Models
for Asset
Digitalization**



**3 Case Study:
Bridge AHI**



4 Conclusions

INTRODUCTION AND BACKGROUND

The digitalization of assets requires a technical design within a designated IT architecture for integrating different systems and platforms

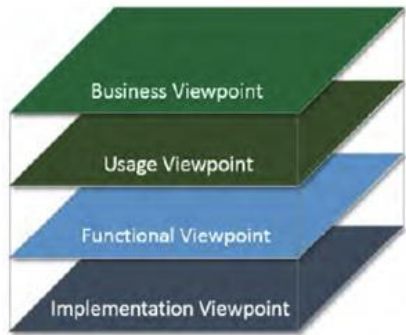

a) IIRA

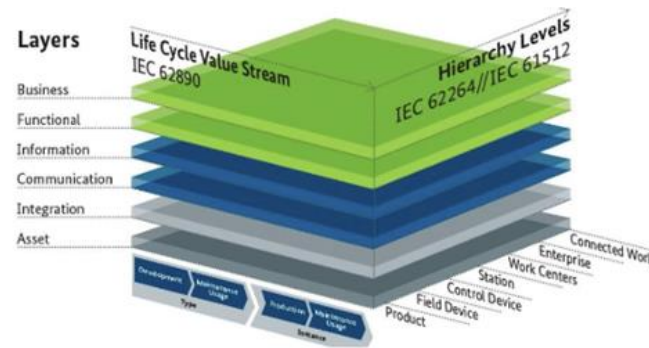

b) RAMI 4.0

Layered reference architectures a)IIRA & b) RAMI 4.0

Digital Maintenance Management (DMM) requires a framework to integrate models in intelligent Apps throughout various phases of the comprehensive MM process. This representation involves transforming raw data from diverse business systems into specific data bases feeding models in Apps for various aspects of asset management process digitalization.

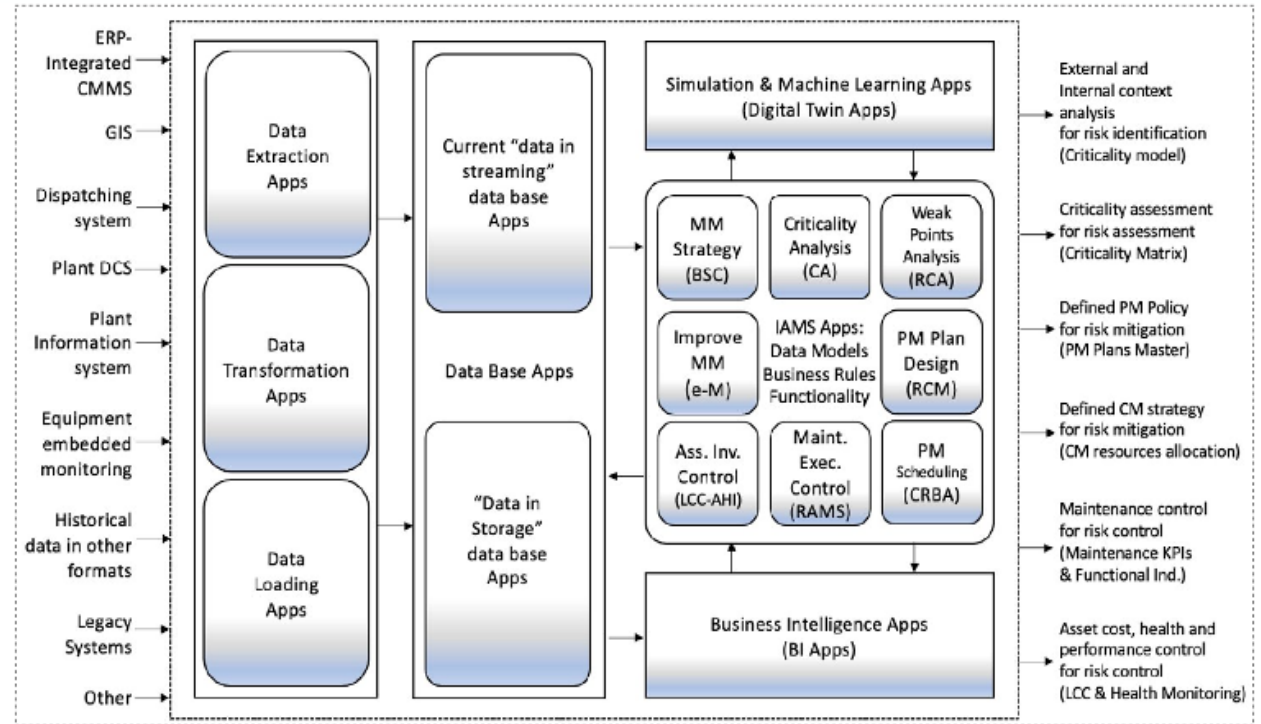

A digital maintenance management framework proposed by Crespo, A. (2022)



INTRODUCTION AND BACKGROUND

1. How can a model-based approach for asset digitalization be effectively introduced to serve maintenance and asset management purposes?
2. In what manner can this approach be integrated with digital maintenance decision-making processes?
3. How can the combined use of an IoT monitoring platform with short-term models, such as CBM models, and long-term models, such as AHI, be applied to enhance asset digitalization and management?

1. The Asset Definition Model

- Describes the comprehensive asset data/information which is implicitly present within the diverse information systems and apps currently utilized for the asset management.

2. The Asset Criticality Model

- This model enables the prioritization of assets, organizing them from highest to lowest criticality and importance within the organization.

3. The Asset Monitoring Model

- Involves signal integration and the establishment of a comprehensive Extract, Transform, Load (ETL) process, facilitating the conversion of signals into valuable asset-related information.

4. The Intelligent Asset Management Model

- These models are selected for the specific management of a given asset.

- ❖ Root Cause Analysis (RCA)
- ❖ Reliability-Centered Maintenance (RCM) or Maintenance Task Analysis (MTA)
- ❖ Condition Based Maintenance (CBM)
- ❖ Maintenance Resources Optimization models (MRO)
- ❖ Reliability, Availability, Maintainability and Safety Analysis (RAMS)
- ❖ Asset Health Indexing (AHI) & Life Cycle Costing (LCC)

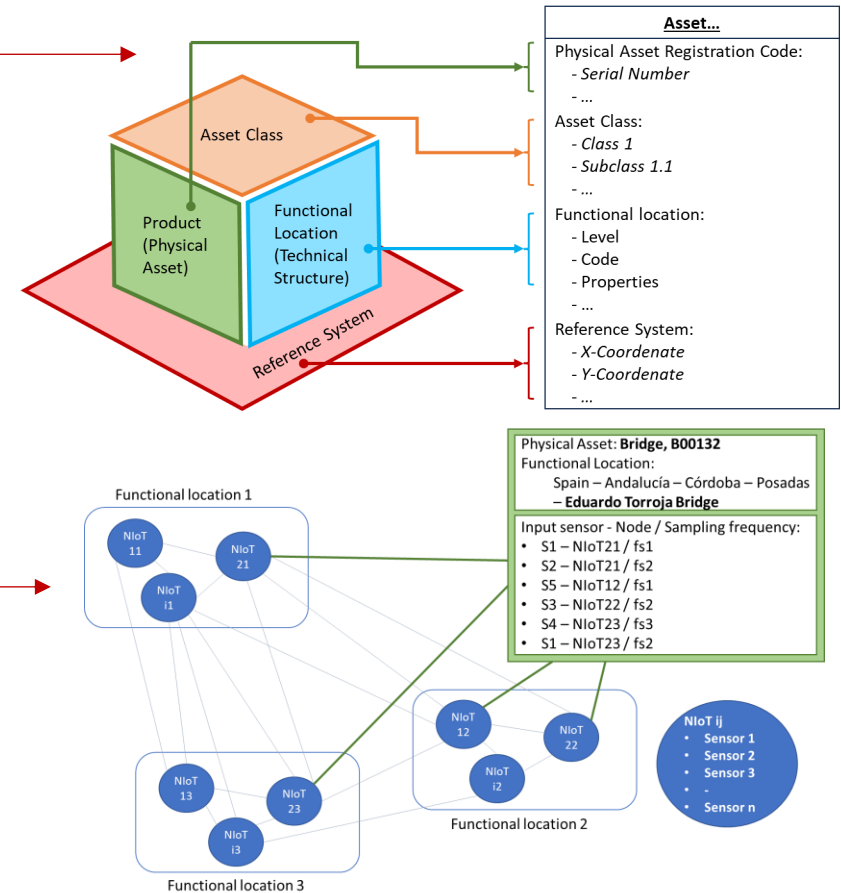

Case Study: Bridge Definition

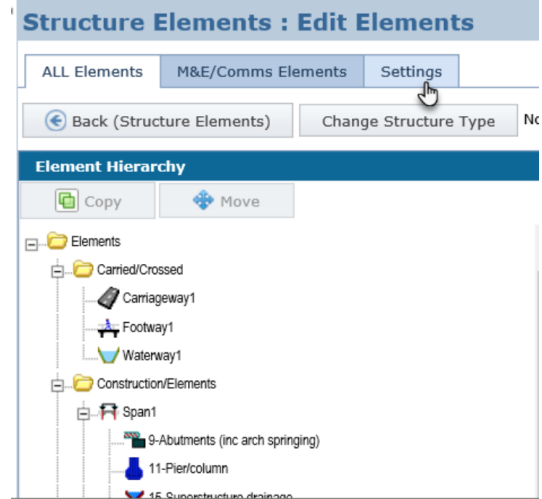

The focus of this analysis centers on the Eduardo Torroja Bridge, situated south of Posadas, Córdoba, spanning the Guadalquivir River.

With its inauguration dating back to 1951, the bridge boasts specific dimensions, including a length of 235 meters, a width of 11 meters, seven cement pillars, and a distinctive appearance featuring eight eyes or inverted bristles supporting the deck.

Data type	Description	Platform	Superstructure
Functional location data	Distant to the coast	160 km	160 km
	Altitude	86 m	86 m
	Average outdoor temperature	22.5°C	22.5°C
	Corrosive atmosphere	No	No
	Dust in suspension	No	No
O&M Cost data	Corrective maintenance cost	10,000€	20,000€
	Preventive maintenance cost	3,000€	2,000€
	Other operational costs	1,000€	1,000€
	Major maintenance cost	60,000€	100,000€

In the context of this analysis, the methodology will be exclusively employed for the components of the roadway surface and superstructure. The pertinent data related to the functional location and O&M cost of these specific components are documented and outlined in this Table.



Case Study: Bridge Monitoring model

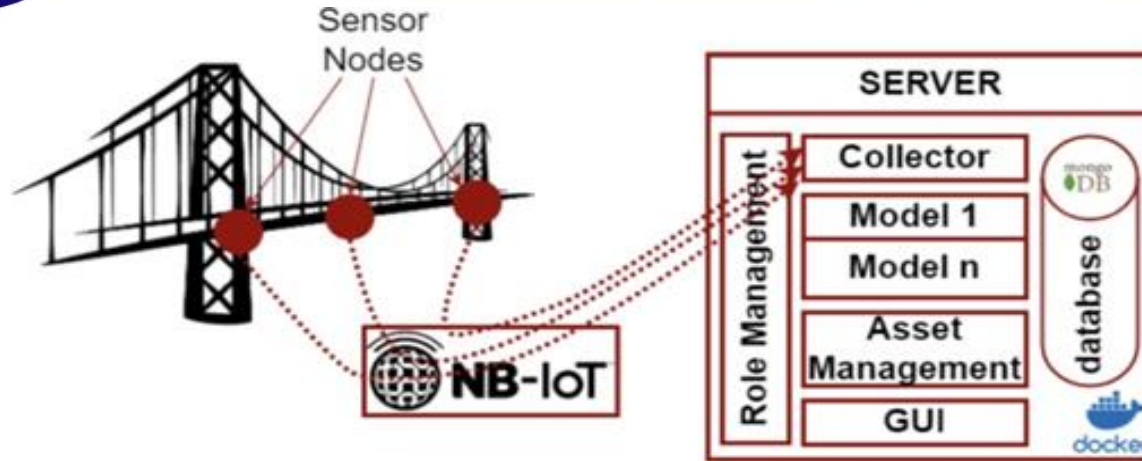

To digitize the asset's condition monitoring, it is imperative to establish integration with information sourced from the IoT/Cloud network strategically positioned at various points across the bridge.

Highlighting specific locations in a roadway section measuring 42 meters in length and 10.5 meters in width.

These nodes serve the dual purpose of capturing information from the bridge and offering data not only exclusive to the roadway due to their location but also insights regarding the condition of other bridge components.

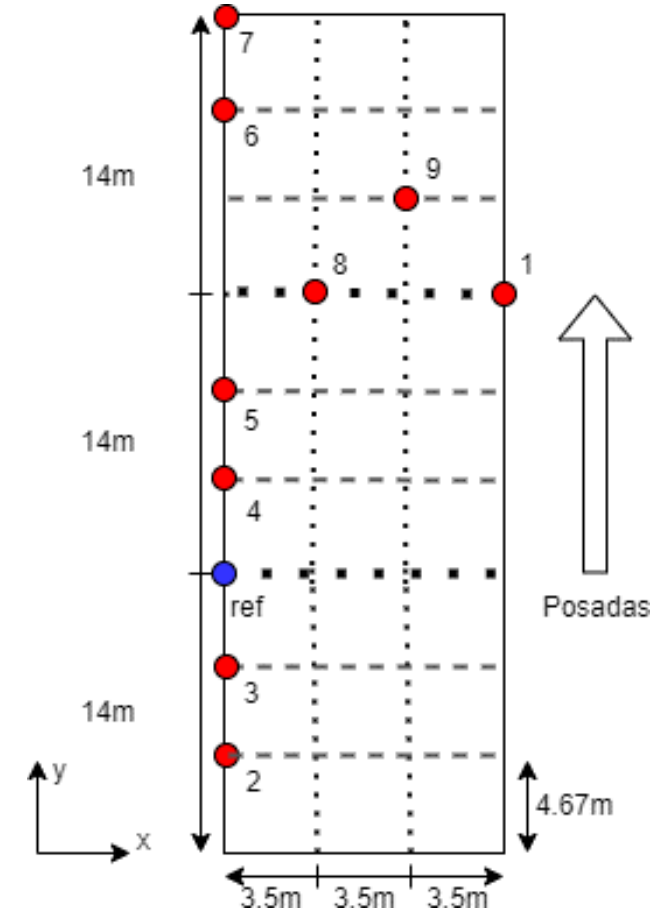

Case Study: Bridge Monitoring model

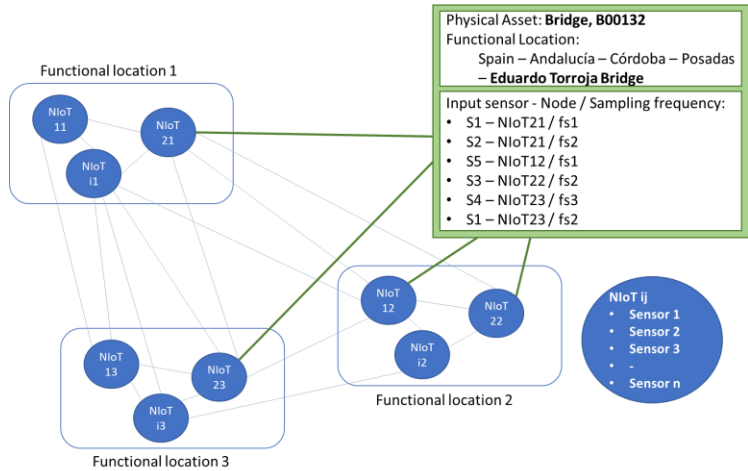

Some assets lack connectivity. NB-IoT offers a cost-effective, long-range solution, ideal for low-power devices. Despite being slow with high latency, its capacity and security make it suitable for quick, affordable deployment.

Nodos asociados a Puente de pruebas

UUID	Alias nodo	Firmware	Estado nodo	Sensores
1998	AIC3 Talud	v.11.3	Activo	4
2001	Nodo Prueba Agrupación	-	Activo	1
2002	Nodo Prueba Agrupación 2	-	Activo	1
2000	Nodo prueba lot	v.11.6	Activo	2

Filas por pagina: 10 | 1 - 4 de 4

Sensores asociados al nodo AIC3 Talud

Descripcion	Tipo sensor	Última medida	Acciones
Acelerometro BMA400 3	Acelerometro BMA400	27/03/2023 10:53:16	👁
Cobertura	Cobertura NB-IoT	27/03/2023 10:52:27	👁
Temperatura-humedad I2C	Temperatura-humedad I2C	27/03/2023 10:53:16	👁
Temperatura-humedad SHT20 2	Temperatura-humedad SHT20	27/03/2023 10:53:16	👁

Filas por pagina: 10 | 1 - 4 de 4

IoT platform caption of information about bridge location, nodes and sensors

Case Study: Bridge Health Index Model

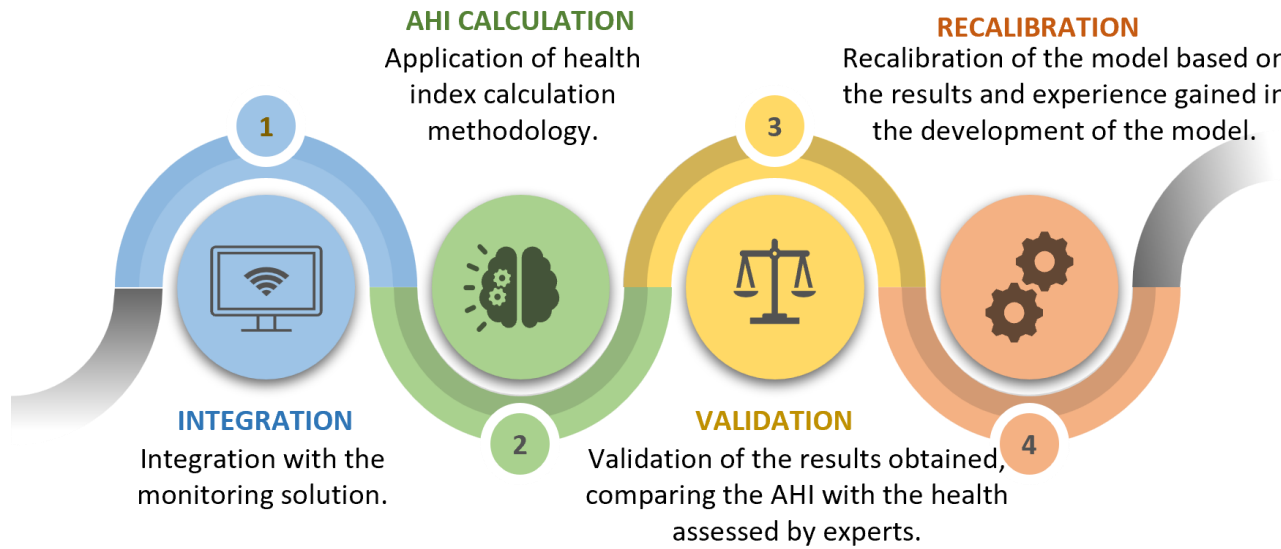

An asset health index model was used, that was integrated with the platform. The IoT platform provides data extraction, processing, and loading (ETL processes), which provide inputs for databases needed by the AHÍ model to:

1. Calculate the asset health index and assess its impact using various factors (asset class, location, load, age, maintenance, sensors, etc.).
2. Update and correct the aging rate over time to project health index and failure frequency, considering maintenance strategies and standard failure rates.
3. Estimate lifecycle cost profiles, accounting for different maintenance operations (preventive, corrective, and major maintenance).

Case Study: Bridge Health Index Model

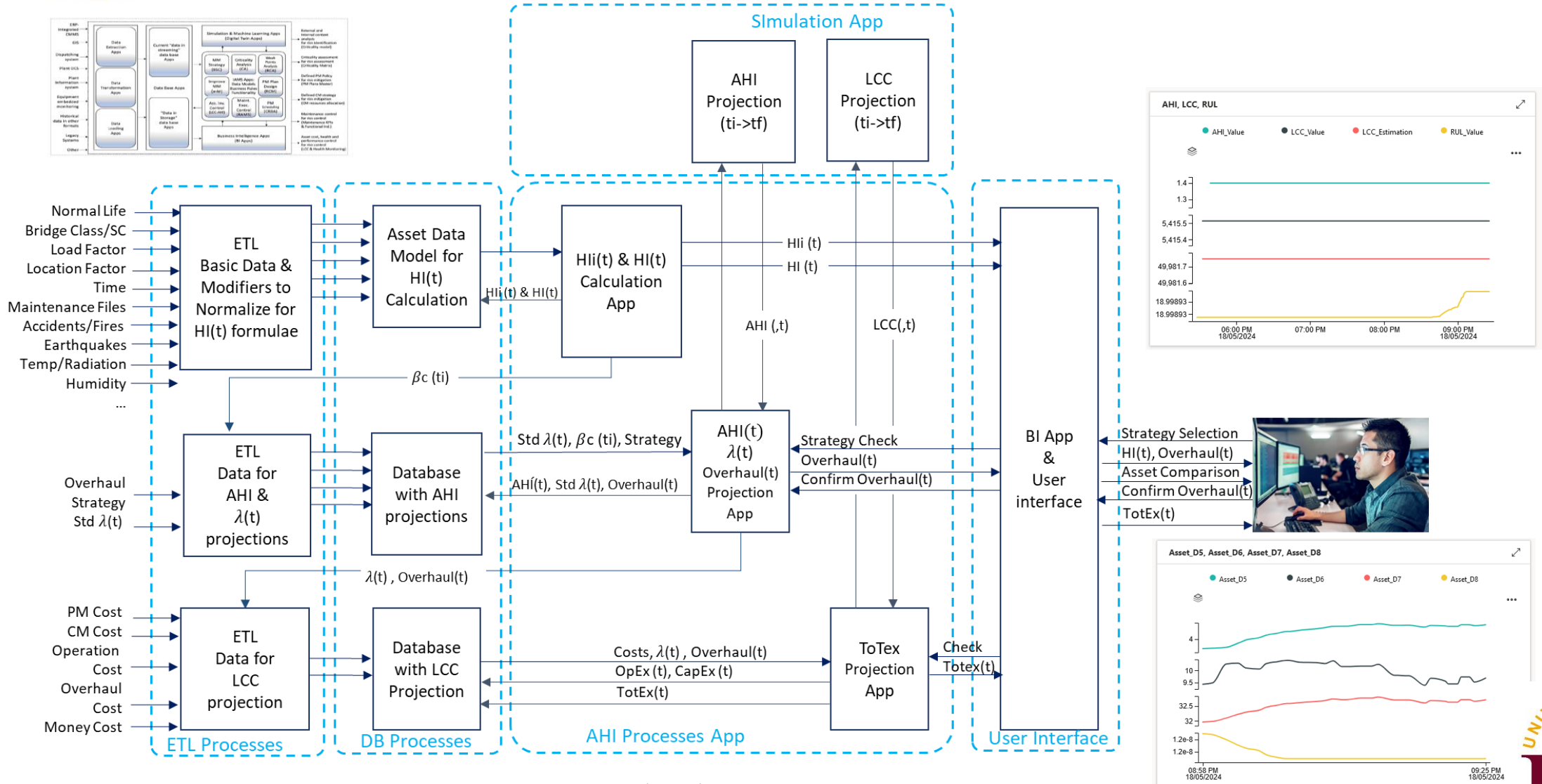

26th -28th. January 2025, Jeddah, KSA

Conclusions

- ❑ This study addresses the critical aspects of maintenance digitization, recognizing the current gap in effective implementation despite the technological advancements in IoT platforms and digital twins..
- ❑ The practical aspects of maintenance management take center stage in the framework, highlighting the need to integrate advanced digitization solutions with a focus on IoT platforms and digital twins.
- ❑ As a use case in the study, a notable contribution of this study is the consideration of an asset health index model, addressing the limitation of many IoT/cloud networks that primarily focus on short-term decisions.
- ❑ This model connects real-time monitoring with medium and long-term planning, including End-of-Life (EOL) management. The strategic integration of the asset health model emerges as an interesting component in digitization, facilitating knowledge management within advanced asset digitization models.
- ❑ In summary, this study provides a framework for effective maintenance digitization, emphasizing practical implementation, model-based perspectives, and the strategic integration of an asset health index model, ultimately contributing to the advancement of digitization practices in the field of maintenance management

Under the patronage of **HRH Prince Khalid Al-Faisal**
Advisor to the Custodian of the Two Holy Mosques & Governor of Makkah Region



المؤتمر الدولي الثاني والعشرون لإدارة الأصول والمرافق والصيانة
The 22nd International Asset, Facility & Maintenance
Management Conference

Digitization - Excellence - Sustainability

THANK YOU!

26-28 January 2025

The Ritz-Carlton Jeddah, Kingdom of Saudi Arabia

www.omaintec.com #OmaintecConf



An Initiative By

Organized by

OMAINTEC
المجلس العربي لإدارة الأصول والمرافق والصيانة
Arab Asset, Facility and Maintenance Management Council

TSG | EXICON.
The Specialist Group • شركة مجموعة المختص